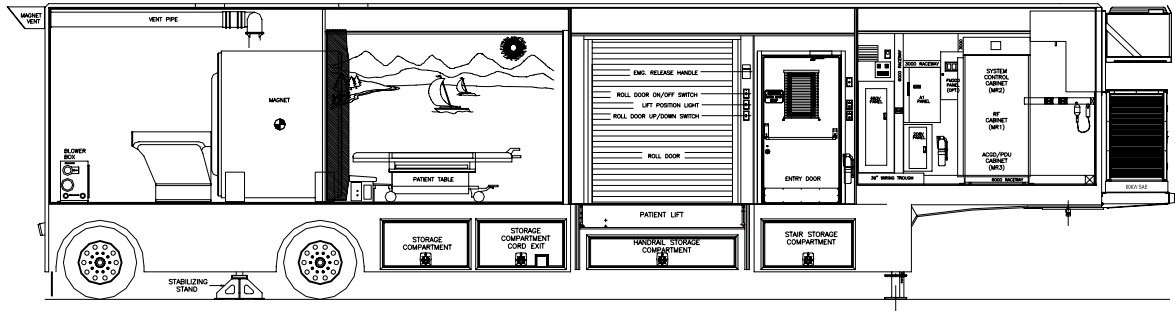




# Site Planning Guide

## GE SIGNA HORIZON 1.0 & 1.5 TESLA MRI SYSTEMS 48' L x 8'-6" W x 13'-6" H USA Mirror Image Unit



© 2007 Oshkosh Specialty Vehicles, All Rights Reserved

This guide contains confidential information of Oshkosh Specialty Vehicles. You may not copy it or any part of it without the written permission of Oshkosh Specialty Vehicles. This manual may be used only by you, and only for the purposes for which it was intended. You may not disclose this manual or the confidential information it contains outside of your company. If you wish to copy any part of this manual, or to use it other than as described above, you must contact Oshkosh Specialty Vehicles seeking permission to do so.

### North America

**Corporate Headquarters**  
Oshkosh Specialty Vehicles  
16745 South Lathrop Ave.  
Harvey, IL  
60426  
USA  
(001) 708.596.5066

### Europe

Oshkosh Specialty Vehicles, Ltd.  
Unit 17, Nelson Way  
Tuscum Trading Estate,  
Camberley, Surrey  
GU15 3DH  
United Kingdom  
(44) 01276.64490

Buys Ballotstraat 6  
3261 LA Oud-Beijerland, Holland  
+31 (0) 186-614322  
Fax . +31 (0) 186-619367  
E-mail: smit@smit-mobile.nl

## List of Revisions

<u>Revision</u>		<u>Date</u>
00	Initial Release	September 2004
01	Updated Logo & Company Reference	February 2007

### Notice

In accordance with our policy of continued product improvement, Oshkosh Specialty Vehicles reserves the right to make changes in the equipment, design, specifications and materials of the product described herein. Any problems or questions related to the components or systems covered in this booklet may be directed to:

Oshkosh Specialty Vehicles  
Attention: Service Department  
16745 South Lathrop Avenue  
Harvey, Illinois  
60426  
USA

Telephone: (001) 800.839.0630 (24/7 Service)  
Fax: (001) 708.596.2480

<http://www.oshkoshsv.com>

# Table of Contents

<b><u>Introduction.....</u></b>	<b><u>5</u></b>
Warnings & Safety Alert Conventions .....	5
<b><u>Support Pad Requirements .....</u></b>	<b><u>6</u></b>
Trailer Weight .....	6
Minimum Support Pad Requirements .....	6
Recommended Support Pad .....	6
Recommended Service Pad.....	6
Support Pad Depth .....	6
Support Pad Levelness .....	6
Vehicle Access .....	6
Steel Reinforced Concrete Pad.....	6
Recommended Attachment to Facility.....	6
Exclusion Zone .....	7
Vehicle Movement.....	7
Vibration / Foundation Design .....	7
Swing Clearance Note.....	7
<b><u>Customer Power Requirements .....</u></b>	<b><u>8</u></b>
Lockout/Tagout.....	8
Electrical Service .....	8
Configuration .....	8
Frequency.....	8
Phase Balance .....	8
Maximum voltage variation.....	8
Connector Type .....	8
Customer Facility.....	8
Voltage Surges .....	9
Power Source Monitoring (Facility Only) .....	9
Ground Conductor .....	9
Magnetic Shielding .....	9
R.F. Shielding .....	9
<b><u>Mobile Grounding Requirements .....</u></b>	<b><u>10</u></b>
Special Grounding Note: .....	10
Mobile Grounding Chart .....	11
<b><u>Telephone and Data Service Requirements .....</u></b>	<b><u>12</u></b>
Telephone Service.....	12
Data Service .....	12
<b><u>Water and Chiller Requirements .....</u></b>	<b><u>13</u></b>
Humidifier Water Fill .....	13
Water Supply Requirements (Sink Option) .....	13
Waste Water Connections (Sink Option).....	13

## Table of Figures

Figure 1: Ground Connection.....	10
Figure 2: Plan View and Pad Layout.....	14
Figure 3: Right Side Elevation .....	15
Figure 4: Left Side Elevation.....	16
Figure 5: Stair/Lift/Wall Elevation .....	17
Figure 6: Russellstoll Service Outlet .....	18
Figure 7: Russellstoll Chart.....	19
Figure 8: Crouse Hinds Service Outlet (Optional) .....	20
Figure 9: Crouse Hinds Chart (Optional) .....	21
Figure 10: Turning Requirements .....	22

## Introduction

The purpose of this document is to provide the basic information needed for site planning. For specific information not contained in this document, please contact Oshkosh Specialty Vehicles.

The mobile unit requires sufficient room to be maneuvered and positioned for setup and takedown. The mobile unit has many storage compartments and service doors that require access during these procedures as well as during operation. The patient lift, entry stair and optional platform require additional space on the passenger side of the mobile unit. Refer to the drawings provided for actual locations of doors, patient lift, and stair sizes and locations.

### Warnings & Safety Alert Conventions

Three types of statements are used throughout this document to warn the operator of potential situations. Always read these statements carefully and take the appropriate safety precautions to ensure a safe environment for all personnel and all property. The statements are as follows:



This type of notice indicates a potentially hazardous situation, which if not avoided, could result in injury or death to the operator of the mobile unit.



This type of notice indicates a potentially hazardous situation, which if not avoided, could result in irreparable damage to the mobile unit.



This type of notice is meant to inform the operator of useful information.

## Support Pad Requirements

The following is a list of recommendations and requirements for a concrete support pad. However, due to varying site conditions, the actual pad design should be prepared by an appropriately licensed structural or architectural engineer.

### Trailer Weight

The weight of the trailer should be considered in the design of the support and service pads. The overall weight of the trailer is approximately 60,000 lbs. The weight on the rear axles is approximately 38,160 lbs. The weight on the King Pin is approximately 21,840 lbs.

### Minimum Support Pad Requirements

A front pad measuring 4'-6" x 11' and a rear pad measuring 15'-1" x 11' will provide the minimum support pad requirements. The smallest cross-hatching as shown on [Figure 2: Plan View and Pad Layout](#), and [Figure 3: Right Side Elevation](#) represents the minimum support pad.

### Recommended Support Pad

A full pad measuring 52'-5" x 11', located as shown on [Figure 2: Plan View and Pad Layout](#) and [Figure 3: Right Side Elevation](#) as the crosshatching, is the recommended support pad.

### Recommended Service Pad

A service pad is recommended to provide adequate service access. The recommended size of the pad is 60' x 18'. See [Figure 2: Plan View and Pad Layout](#), for details.

### Support Pad Depth

Recommendations for the width and length of the pad are given above. Based upon the weight distribution information given in [Figure 3: Right Side Elevation](#) and existing site conditions, the depth should be determined by a local contractor. It is recommended that non-ferrous reinforcement materials be used for pad reinforcement. GE must approve plans for pad construction.

### Support Pad Levelness

The support pad must be level to ensure proper operation of the MRI system. The pad must not exceed .125" deviation in 10'-0". If the minimum support pads are selected, rather than the recommended single pad, they must also meet this specification.

### Vehicle Access

A firm, level surface is required around the mobile unit to provide access to the tractor/trailer, aid with patient handling, servicing the unit, and delivering of cryogens.

### Steel Reinforced Concrete Pad

Nonferrous reinforcement materials are recommended. If ferrous materials are used contact GE for the maximum weight allowed per foot.

### Recommended Attachment to Facility

An inflatable air bag or soft seal is recommended at the point of connection from the unit to the facility. Fixed or solid connections may hinder imaging quality. Contact OSV or the local GE representative prior to construction if the proposed connection varies from the recommended.

### **Exclusion Zone**

An area of 5'-0" x 5'-0", located directly below the magnet vent should be fenced off to prevent injury in the event of magnet quenches. The helium gas must be allowed to vent, unrestricted, to a non-accessible area, allowing the helium gas to dissipate.

### **Vehicle Movement**

The MRI is very sensitive to vibration and moving metal. Consequently, all vehicle traffic shall be kept as far away as possible from the pad. Moving ferrous materials having the listed masses should be limited to areas as described in the GE site planning publication. Contact GE to obtain the latest version.

### **Vibration / Foundation Design**

Please contact GE Medical Systems for the latest system specific vibration requirements.

### **Swing Clearance Note**

Please verify the actual dimensions of the rearmost projections on the cab of your tractor to the centerline of tandem suspension or centerline of the fifth wheel plate on your tractor. Refer to [Figure 10: Turning Requirements](#) for proper tractor sizing information.

## Customer Power Requirements



It is the operators' responsibility to verify that the shore power receptacle is of the same type and voltage as the connection that is supplied by Oshkosh Specialty Vehicles. Failure to do this can result in injury or death to the operator of the mobile unit as well as irreparable damage to the mobile unit.



The standard connector for the unit is a Russellstoll DS2504MP000/DF2032 480V 200A Plug. An acceptable optional connector is the Crouse Hinds # AP 20457. If an existing site currently implements a different connector or connector configuration, please contact Oshkosh Specialty Vehicles in order to arrange for a compatible power connector before the unit leaves the facility.

### Lockout/Tagout

A Lockout/Tagout provision in accordance with OSHA Standard 1910.147 is required. The facility shore power disconnect device must be located within 40'- 0" of the unit and must provide for an effective lockout/tagout to facilitate safe service and maintenance of the unit.

### Electrical Service

A single electrical power source is required for operation of the MRI system.

480 Volt A.C., 3 Phase, 125 KVA, fused at 150 Amps

### Configuration

Three phase, five wire, wye connection, with ground and neutral (not less than AWG #1/0).

### Frequency

60 Hz  $\pm$ 3Hz

### Phase Balance

The phase balance is + 2% maximum phase-to-phase line voltage difference lowest phase.

### Maximum voltage variation

The maximum voltage variation is  $\pm$ 10% from nominal steady state (under the worst case conditions of line voltage)

### Connector Type

The unit is supplied with a 50-foot cable and male connector. The connector is a Russellstoll 200 Amp plug #DS 2504 MP000/DF2032.

The optional Crouse Hinds connector male plug # AP20457 is also available.

### Customer Facility

The facility must have the matching receptacle as specified in [Figure 6: Russellstoll Service Outlet](#) and [Figure 7: Russellstoll Chart](#). The receptacle is a Russellstoll #DF 2504 FRAB0.

The optional Crouse Hinds facility receptacle # AR2041 may also be used as specified in [Figure 8: Crouse Hinds Service Outlet](#) and [Figure 9: Crouse Hinds Chart](#).



## **Voltage Surges**

Transient voltage variations caused by external loads must not:

- Exceed + 5%
- Exceed five cycles duration
- Occur more than ten times an hour.

## **Power Source Monitoring (Facility Only)**

**NOTE: Perform a power audit first.**

A power analyzer should be used to check the proposed Mobile MRI Series facility site power for average line voltage, surges, sags, reclosures, impulses, frequency and microcuts. A period that includes two weekends should be used to simulate several days of normal use. Analysis of the data and site history of any previous power problems with other X-ray systems or computer installations should be reviewed with your power and ground representative. Verify “brown-out” (low voltage) conditions, which may occur during summer months, will not exceed the allowable range.

Some analyzer models that are suitable for power monitoring are:

- Dranetz Model 658
- Dranetz Model 656A
- BMI 3630
- RPM

## **Ground Conductor**

An insulated ground conductor sized in accordance with National, State, and local codes shall be installed between the facility vault and the MRI System ground bus location in the power distribution unit.

## **Magnetic Shielding**

The MRI unit is equipped with magnetic shielding. The exclusion zone for cardiac pacemakers, neurostimulators, and other biostimulation devices is recommended at 5 gauss (0.5mT). Signs provided by GE, must be posted to alert all who approach the unit of this requirement. The appropriate warning signs are permanently attached to the scan room doors.

The 1.0T and 1.5T magnet systems exclusion zone (5) gauss is restricted to within 6” of the exterior of the mobile unit.

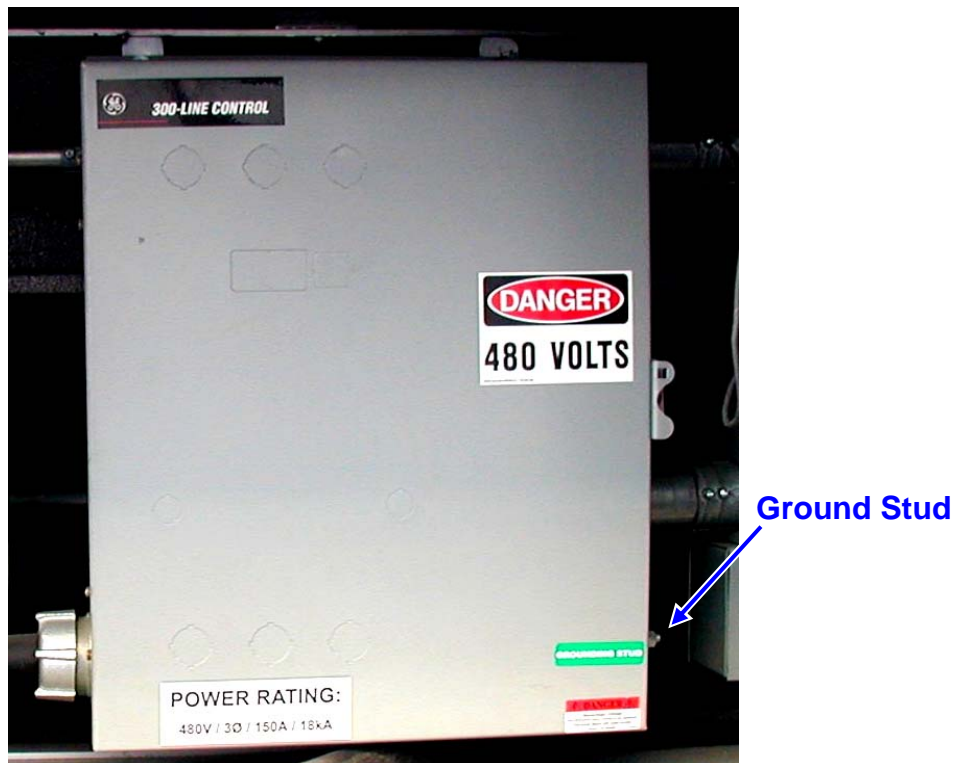
## **R.F. Shielding**

The R.F. shield is included with the MRI system and will provide minimum level of attenuation: 10Mhz – 100Mhz, 85db (plane wave, electric field, magnetic wave).

## Mobile Grounding Requirements

### Special Grounding Note:

The unit must have an earth driven ground rod within five (5) feet of the hospitable power receptacle. A grounding cable of a minimum #1/0 AWG must be connected between the grounding rod and the grounding pin of the hospital power receptacle. Another cable, to be kept as short as possible, may also be connected between the ground stud on the Incoming Power Distribution Panel and an earth driven ground rod See [Figure 1: Ground Connection](#) below. A separate grounding conductor must still be run with the phase conductors to the source of power from the grounding pin of the hospital power receptacle in accordance with NEC 2002 Article 250-24.



[Figure 1: Ground Connection](#)

**NOTE: For the associated drawing please refer to the following chart for grounding requirements.**

## Mobile Grounding Chart

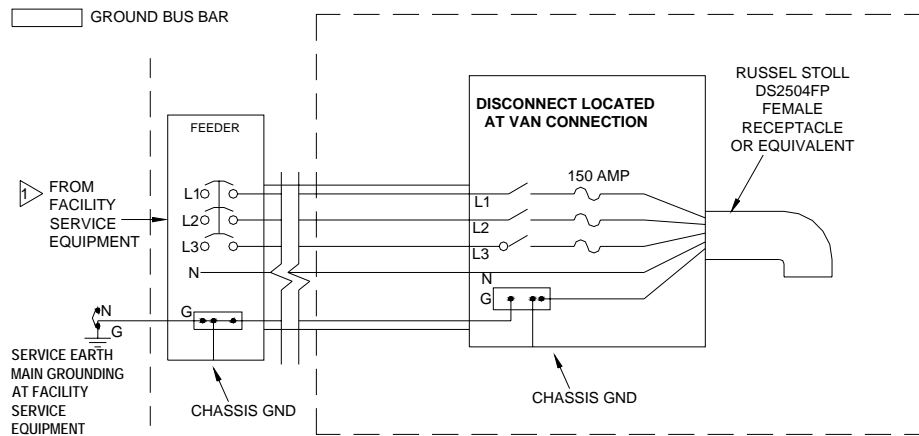
### MOBILE GROUNDING REQUIREMENTS

**NOTE:**

- ALL WORK TO BE DONE IN ACCORDANCE WITH NATIONAL AND LOCAL ELECTRICAL CODES INFORMATION SHOWN HERE IS ONLY A RECOMMENDATION. MUST BE VERIFIED FOR SITE NATIONAL AND LOCAL CODES.

- GROUND WIRES INSIDE ENCLOSURES TO BE TAPED GREEN FOR ENTIRE VISUAL LENGTH FOR IDENTIFICATION.

▷ MAIN BONDING JUMPER BETWEEN GROUNDED (NEUTRAL) CONDUCTOR AND EQUIPMENT GROUNDING CONDUCTOR TO BE PROVIDED IN FACILITY SERVICE EQUIPMENT AND DOWNSTREAM AT SEPARATELY DERIVED SYSTEM TRANSFORMER SECONDARY AS SHOWN.



**GROUNDING**

The ground for our system shall originate at the system power source, i.e., transformer or first access point of power into a facility, and be continuous to our system power disconnect in the room. This ground can be spliced with "High Compression Fittings" and should be terminated at each distribution panel it passes through. When it is broken for a connection to a panel, it shall be connected into an approved grounding block with the incoming and outgoing ground in this same grounding block, which is then connected to the steel panel never using the steel panel never using the steel or other material of the panel as the block

The connection at the power source shall be at the grounding point of the "Neutral-Ground" if a "Wye" transformer is used, or typical grounding points of a separately derived system. In the case of an external facility, it shall be bonded to the facility ground point at the service entrance.

**GROUNDING WIRE**

The ground wire shall be copper wire with a minimum of AWG 1/0 or the same size as the power feeders whichever is larger. This means that if there is a primary feeder to a distribution panel of 500 MCM with a secondary feeder to our system of AWG 1/0 wire, the ground to the distribution panel shall be 500 MCM with and AWG 1/0 to our system. The ground wire impedance from our system disconnect, including the ground rod shall not have an impedance greater than 2 ohms to earth as measured by one of the applicable techniques described in Section 4 of ANSI/IEEE Standard 142-1982.

Harry E. Rauworth  
Debra C. Balis  
April 22, 1999

## Telephone and Data Service Requirements

### Telephone Service

The mobile unit is supplied with three (3) telephone connections.

The connector type that is used and supplied by Oshkosh Specialty Vehicles is an all-weather Hubbell PH-6595 (inlet) with a model PH-6624 connector body.

The customer is required to purchase and install three (3) all weather Hubbell PH-6597 phone outlets for use at the site.

Three all weather Hubbell PH-6599, 50'-0" telephone connecting cables are included with the unit. If additional cables are required, the customer must purchase them.

### Data Service

The mobile unit is supplied with three data line connections that utilize RJ-45 outlets.

The customer is required to purchase the data connection cables for use with the data line connections. The data line connections each require a 50'-0" CAT-5E cable with RJ-45 connections.

## Water and Chiller Requirements

### **IMPORTANT**

During winter conditions, provisions must be made to ensure that water lines do not freeze because of weather conditions.

### Humidifier Water Fill

The unit contains a water storage tank for the humidifier. This tank is located in the equipment room and must always contain water to insure the specified humidity level remains constant. There are two options for filling the tank:

- A  $\frac{3}{4}$ " garden hose coupling male threaded hose connection is located outside under the equipment room on the left side front near the fifth wheel.
- A fill port is located in the humidifier for manual fill capability.

### Water Supply Requirements (Sink Option)

The mobile unit will be supplied with a  $\frac{3}{4}$ " diameter, 20'-0" long hose terminated with a  $\frac{3}{4}$ " I.P.S male threaded hose connector located on the left side of the mobile unit. The facility must provide a  $\frac{3}{4}$ " female connector and a water supply that meets the following specifications:

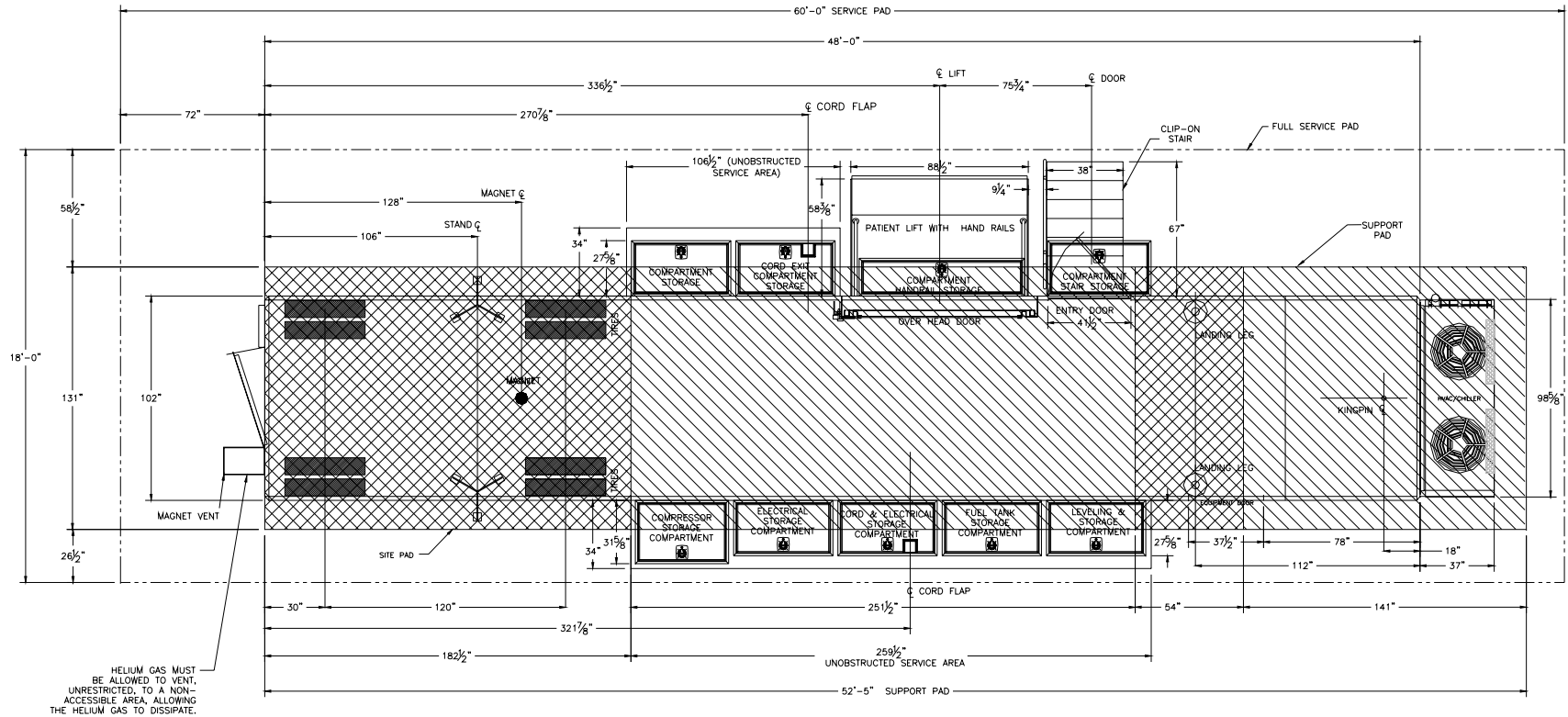
- A flow rate of 5 gallons per minute.
- 45-60 PSI.
- A maximum temperature of 70°F.

### Waste Water Connections (Sink Option)

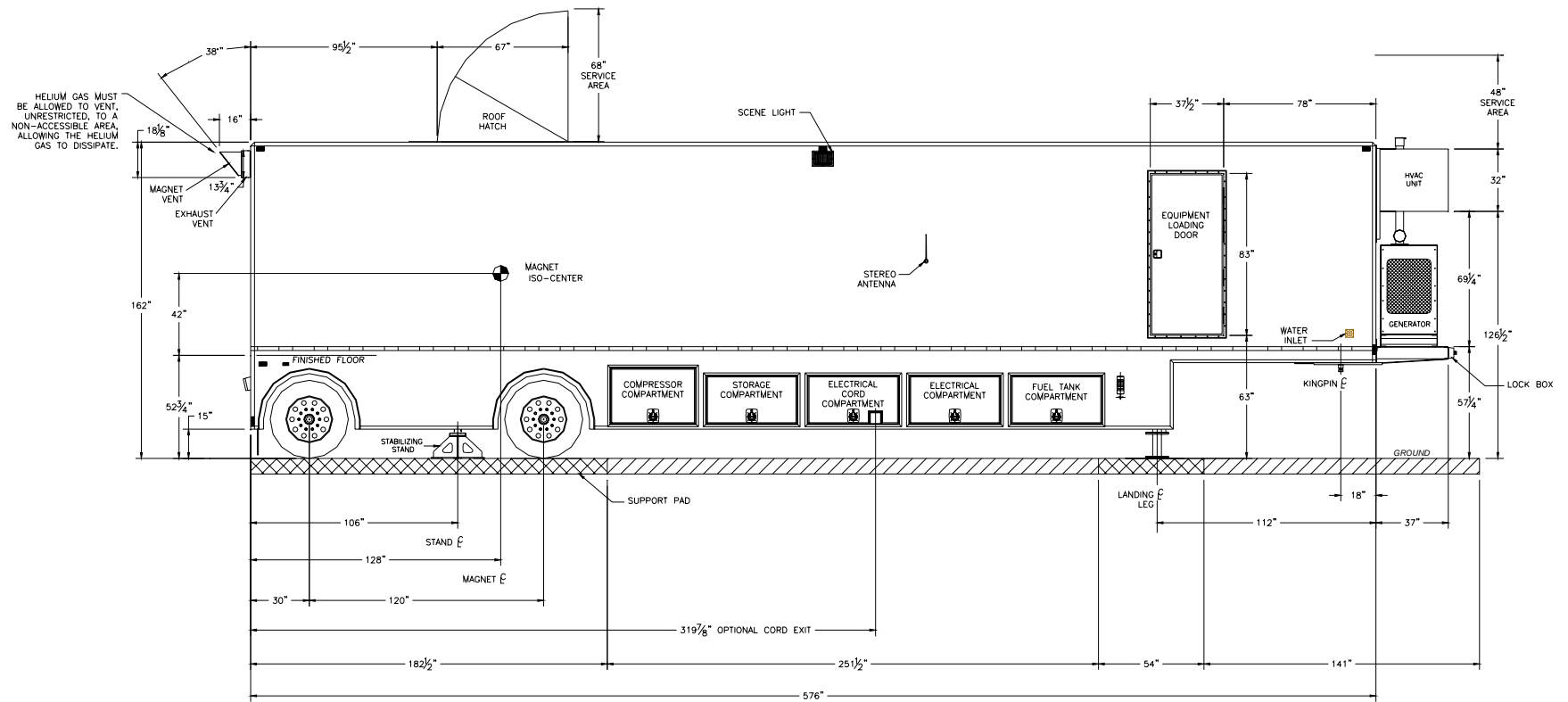
A  $1\frac{1}{2}$ " IPS male connection is required to sink wastewater.

Any pipes and drains within 20'-0" of the magnet isocenter should be of non-ferrous materials such as PVC, copper, or brass. All plumbing must comply with all applicable codes.

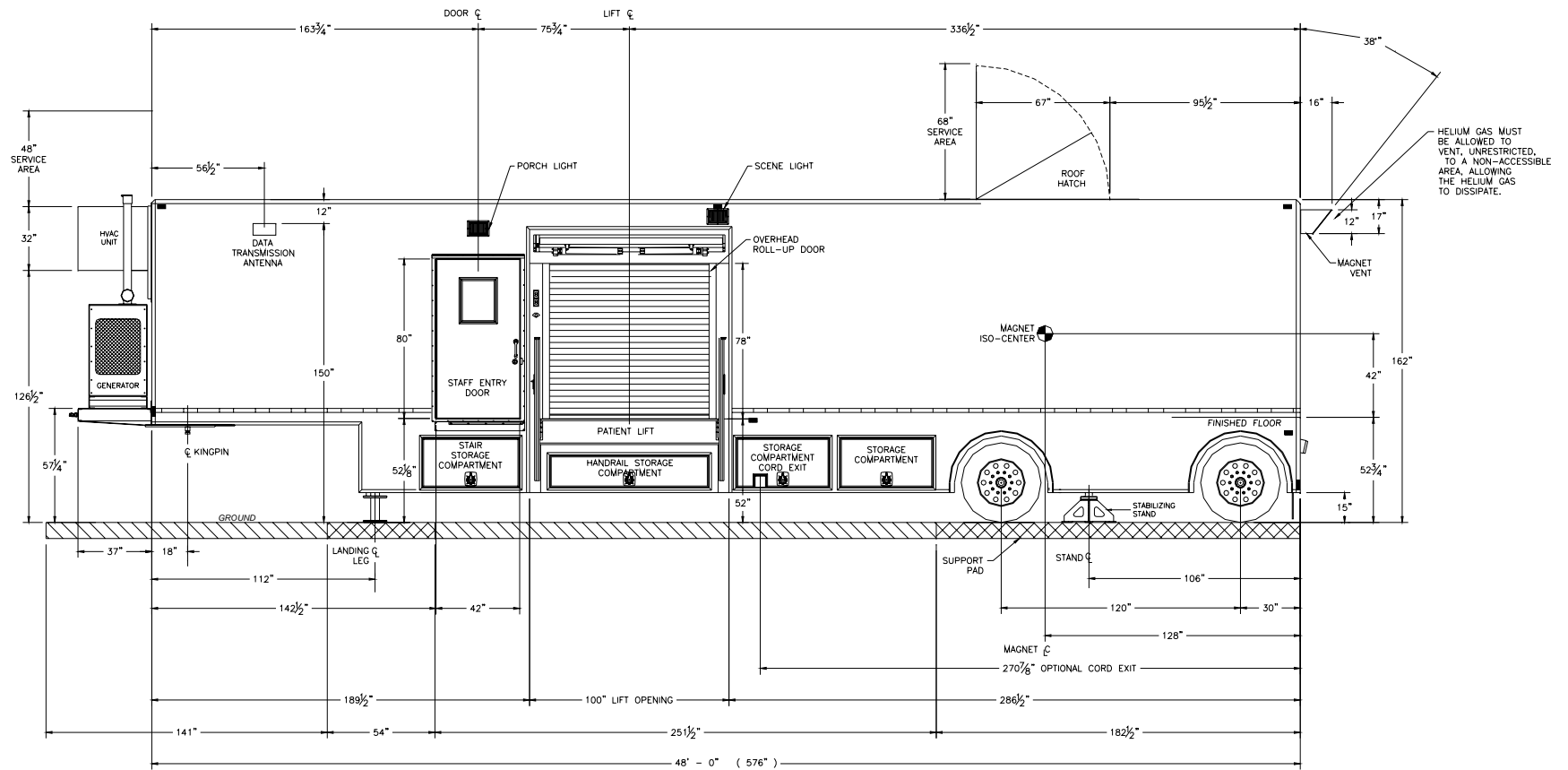
The mobile unit is supplied with a 20'-0" long  $1\frac{1}{2}$ " diameter hose that is terminated with a  $1\frac{1}{2}$ " male threaded connector for sanitary wastewater drainage located on the left side of the mobile unit. The facility must provide means of sanitary wastewater drainage from the system, which complies with all local applicable codes.



**Figure 2: Plan View and Pad Layout**

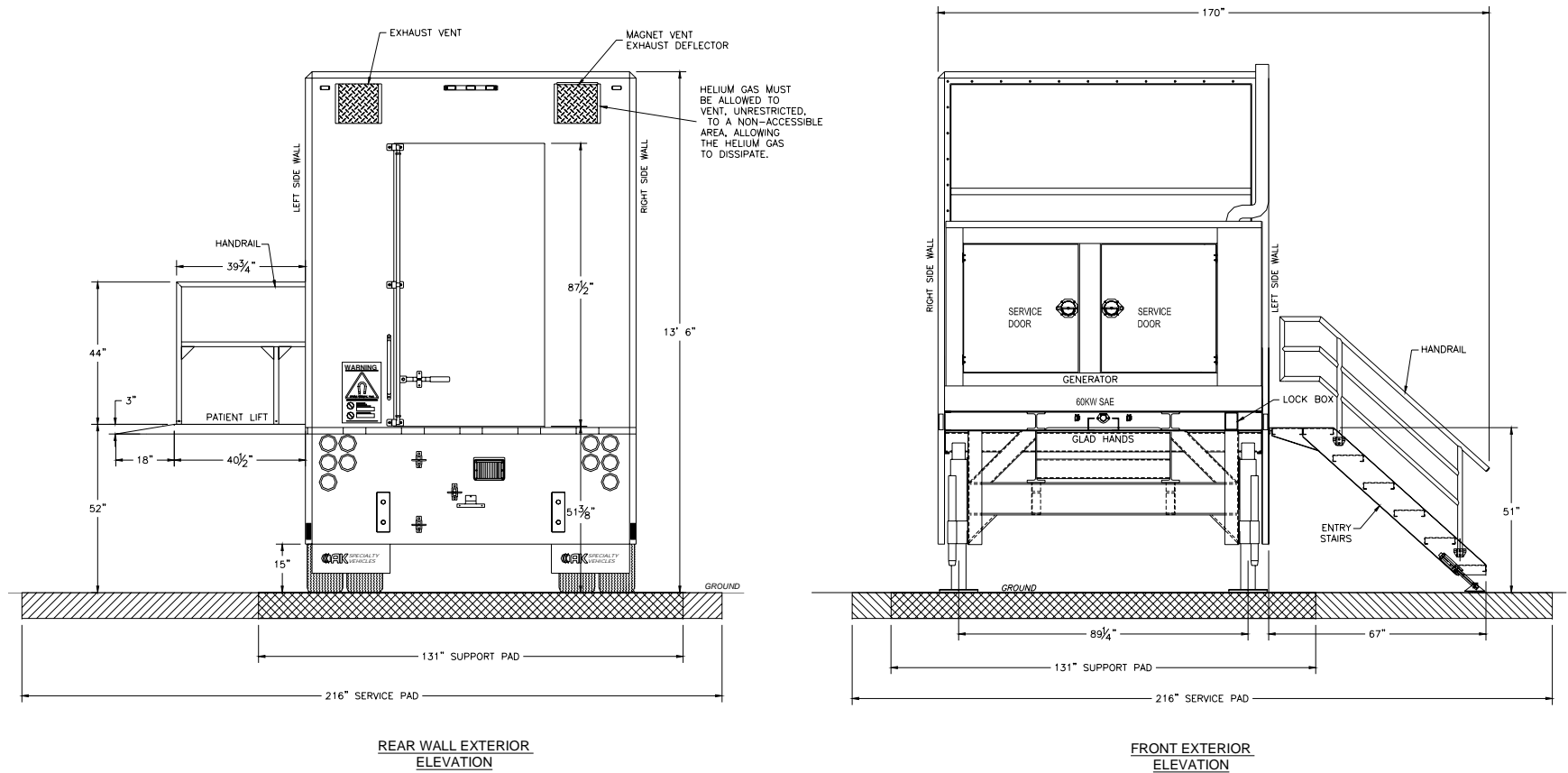


**Figure 3: Right Side Elevation**

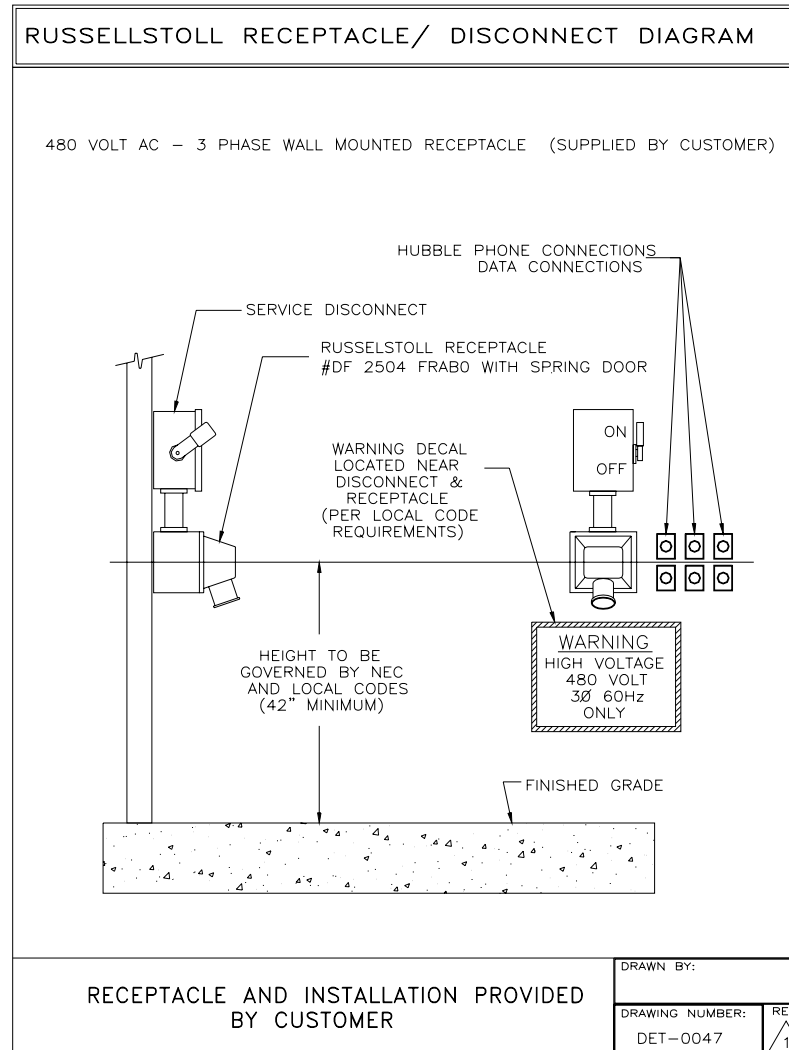


**Figure 4: Left Side Elevation**

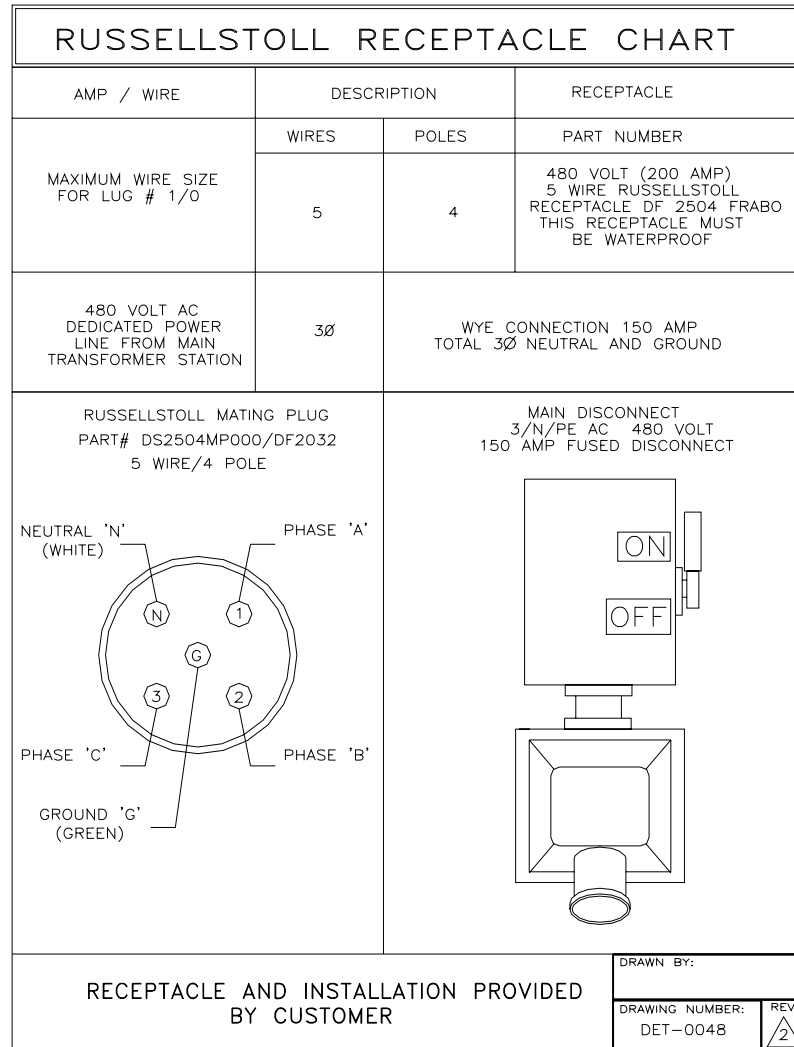




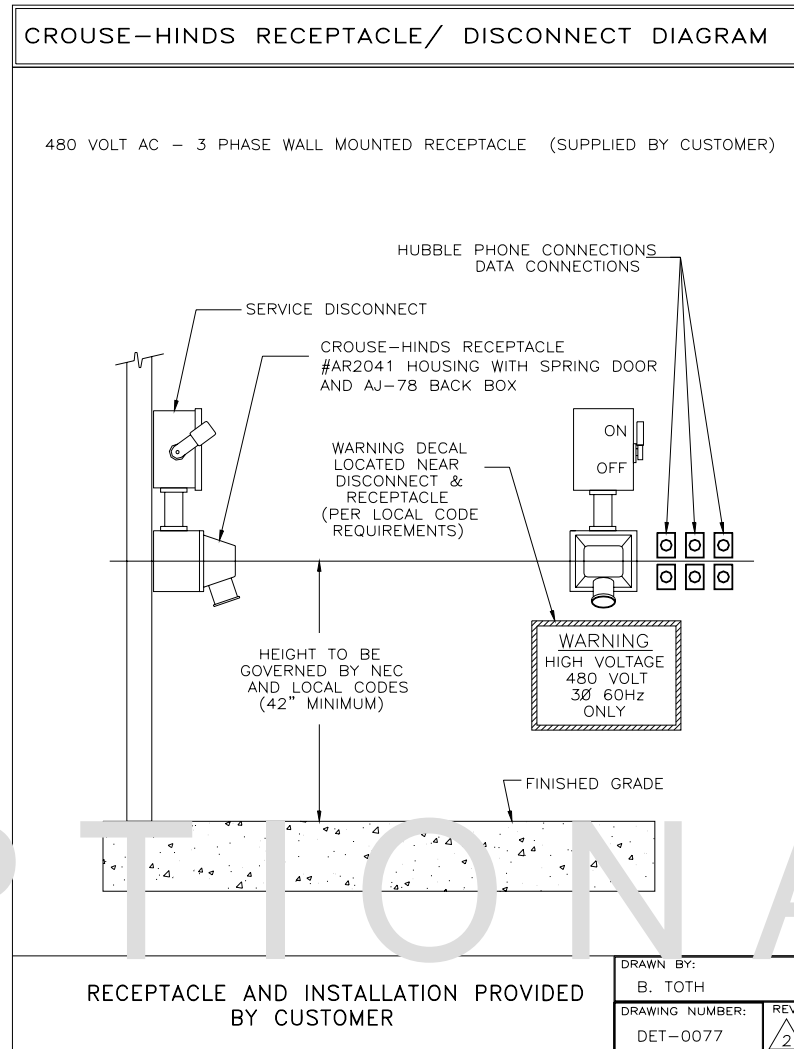
**Figure 5: Stair/Lift/Wall Elevation**



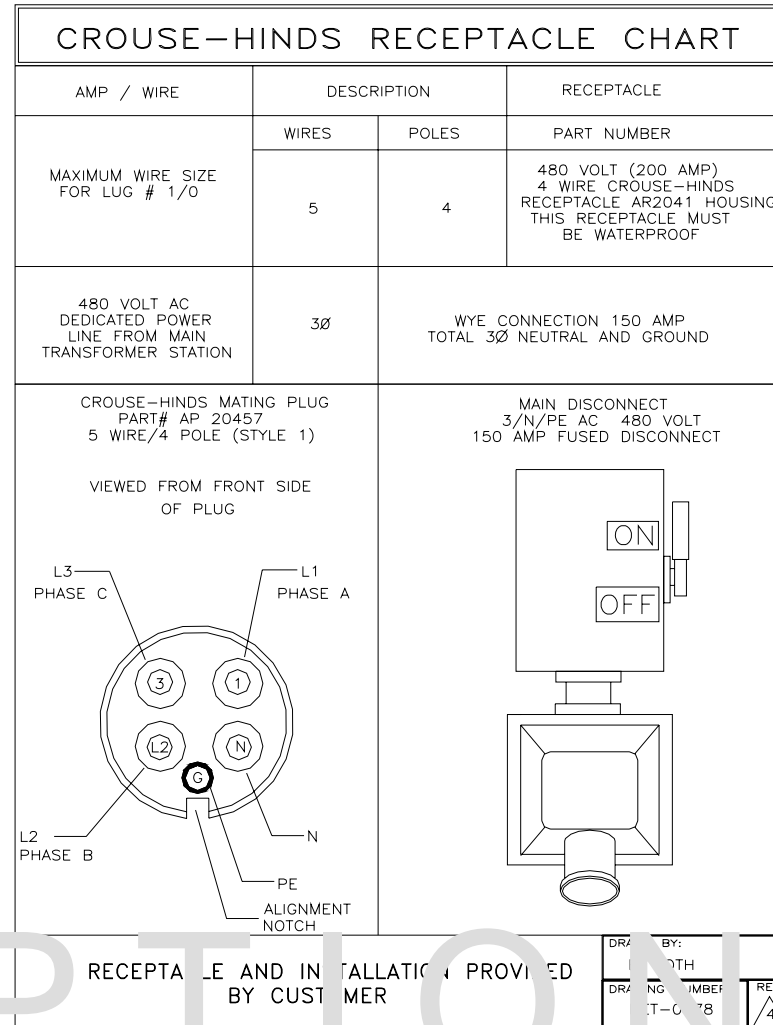
**Figure 6: Russellstoll Service Outlet**



**Figure 7: Russellstoll Chart**

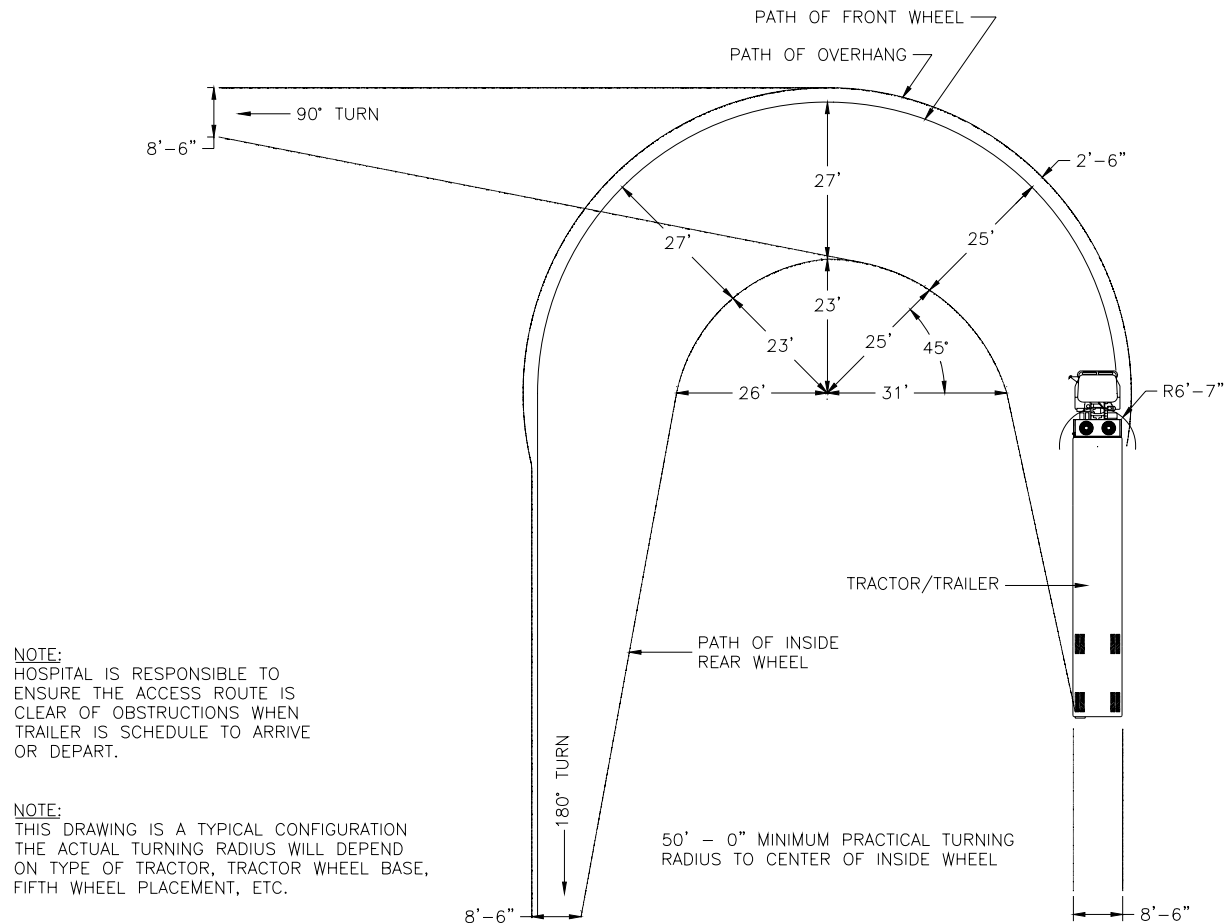


**Figure 8: Crouse Hinds Service Outlet (Optional)**



**Figure 9: Crouse Hinds Chart (Optional)**

A minimum dimension of 79" is required from rearmost projection to centerline of kingpin. This provides swing clearance for generator set which is mounted on the front of the trailer. Hospital is responsible to ensure the access route is clear of obstructions when the trailer is scheduled to arrive or depart. The 50' minimum outside turning radius shown here has been calculated using an international harvester (Navistar) tractor Model COF-9670 with a 161" wheelbase. Turning radius will vary with towing tractor. Customer must confirm the turning radius on their tractor and prepare each site with adequate space to accommodate it.



**Figure 10: Turning Requirements**